



PLAZA FACADE DESIGN HANDBOOK

Caldwell: Indian Creek Plaza
Plaza Facade Design Handbook
08 December, 2016

GGLO DESIGN



Table of Contents

| | | |
|----|---------------------|----|
| 01 | Concept Narrative | 03 |
| 02 | Code Review | 04 |
| 03 | How to Use this Kit | 05 |
| 04 | Basic Restoration | 12 |
| 05 | Improvement Kit 1 | 13 |
| 06 | Improvement Kit 2 | 14 |
| 07 | Improvement Kit 3 | 15 |



This document, the information and designs presented in it, have been contributed to by the work of the University of Idaho graduate students for the 2016 LARC 556 studio, and Professor Beth Scott: Carly Boise, Jordan Campbell, Megan Hoover, Eamonn Parke, and Celeste Valle

Plaza Facade Design Handbook

Indian Creek Plaza | Downtown Caldwell, ID 83605

Table of Contents | 08 December, 2016





Concept Narrative

Business Owners adjacent to the future Indian Creek Plaza see an opportunity for their businesses to embrace and activate the plaza by opening up and revamping their building facades of the historic structures. As these facades form the walls of Indian Creek Plaza, it is important that these "walls" support the functions and identity of the Plaza.

These facade improvement kits seek to embrace both the impending change of this area and the history of the City of Caldwell. Interventions at these facades should be authentic, true to the current time, appropriate for the region, and reverent of the roots of the City of Caldwell. Three different approaches here address three different aesthetics that, when applied in sum or part, can freshen and activate the Plaza in a cohesive, but lively manner.

The Plaza concept of Palimpsest has appropriate applications here:

Palimpsest: n. Something that has changed over time and shows evidence of that change (Merriam-Webster)

Code Review

CITY OF CALDWELL - CITY CENTER ZONING DISTRICT DESIGN GUIDELINES

- **Building Materials** used should be of a high quality and appropriate to the context of the surroundings, such as: red brick, stone, or stucco. When feasible, repairing or replacing existing stucco or exposing and restoring existing brick facades should be the preferred material employed. Additional acceptable materials include wood, tile, or yellow brick. Standard color selections should be natural or muted neutrals, and where appropriate the use of "color themes" and vibrant color is acceptable.
- *Additional Recommendations: While material selection is encouraged to be restored brick or stucco for the main building facade, accent material choices should be stained and sealed wood, painted wood, painted brick, tile, metal panel, or terracotta cladding, limited to approximately 20% of the overall facade. It is recommended that these accent materials are used in a thoughtful and appropriate application, requiring design approval. It is also recommended to require design approval for use of "color themes" or vibrant colors.*
- **Wall Openings and Fenestration at ground level** shall provide substantial glazing to allow for significant transparency into the building. Transom windows should be divided consistently across the facade, while maintaining larger shop-front windows should be provided below. Base panels below shop windows should be no more than 24 inches in height.
- **Wall Openings and Fenestration above the ground level** shall be made of wood, vinyl-clad wood, aluminum-clad wood, or fiberglass, with clear glazing required (no more than 10% reduction in daylight reduction). At a minimum, windows must meet current energy efficiency industry standards. Total area of fenestration on a facade must not be greater than 33% (excluding storefronts).
- *Additional Recommendations: Wall opening and fenestrations are preferred to be operable and of a high quality material, exceeding current energy efficiency industry standards. Existing window openings should be maintained where feasible.*

- **Weather Protection**, to be provided at all building entires to provide shelter from the elements, and increase the comfort of the pedestrian.
- *Additional Recommendations: weather protection is encouraged to match the color palette of the building, suggested material to be blackened steel with lighting incorporated. Clear height from the ground should be no less that 10'-0", and not project as to interfere with alley access and functionality.*
- **Commercial Signage** should be provided to identify the building's location, use, and entires. Except for temporary signage, permanent signage should be durable and capable of withstanding the elements, and should reflect the type and scale of materials used on the building. Signage shall be designed and constructed by a professional and be permanently attached to the building or other structure. Signage lighting should minimize light /glare onto adjacent properties, be shielded when necessary, should not blink or change intensity/color, shall be energy efficient, and not create hazards for pedestrians or motor vehicles. Signage copy shall relate only the names of business, promote overall legibility with simplicity, and should not exceed 40% of total sign area.
- *Additional Recommendations: Commercial Signage should not interfere with public pedestrian accessibility. Signage should be block letters whenever possible, no more than 18" in height. Back-lit box signs are not acceptable. Provide building signage as well as pedestrian oriented signage near the building entry.*
- **Blank Walls** are considered untreated walls exceeding 6 feet high by 20 feet wide visible from a public street or pedestrian pathway; these are prohibited.
- *Additional Recommendations: To mitigate blank walls provide a treatment by providing new openings, screening element for vegetation to climb, planter boxes, mural artwork, or display windows for artwork or local events.*
- **Design Imagery** provided in this handbook is intended for use by building owners as design inspiration to revitalize building facades. While these ideas are encouraged, design is not limited to imagery provided, unless specifically stated. Actual facade design must be approved by the Caldwell Design Review Board.

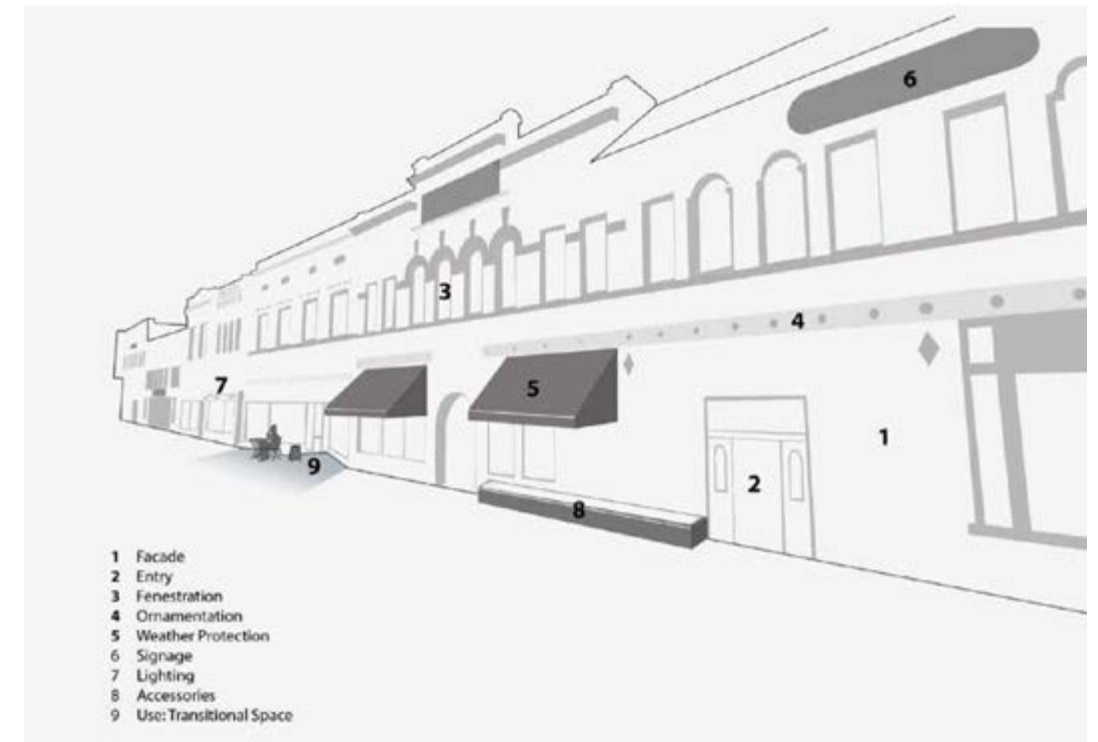

Diagram by University of Idaho graduate students for the 2016 LARC 556 studio.



Example of Mural to mitigate blank wall. Diagram by University of Idaho graduate students for the 2016 LARC 556 studio.

Plaza Facade Design Handbook

Indian Creek Plaza | Downtown Caldwell, ID 83605

Code Review | 08 December, 2016

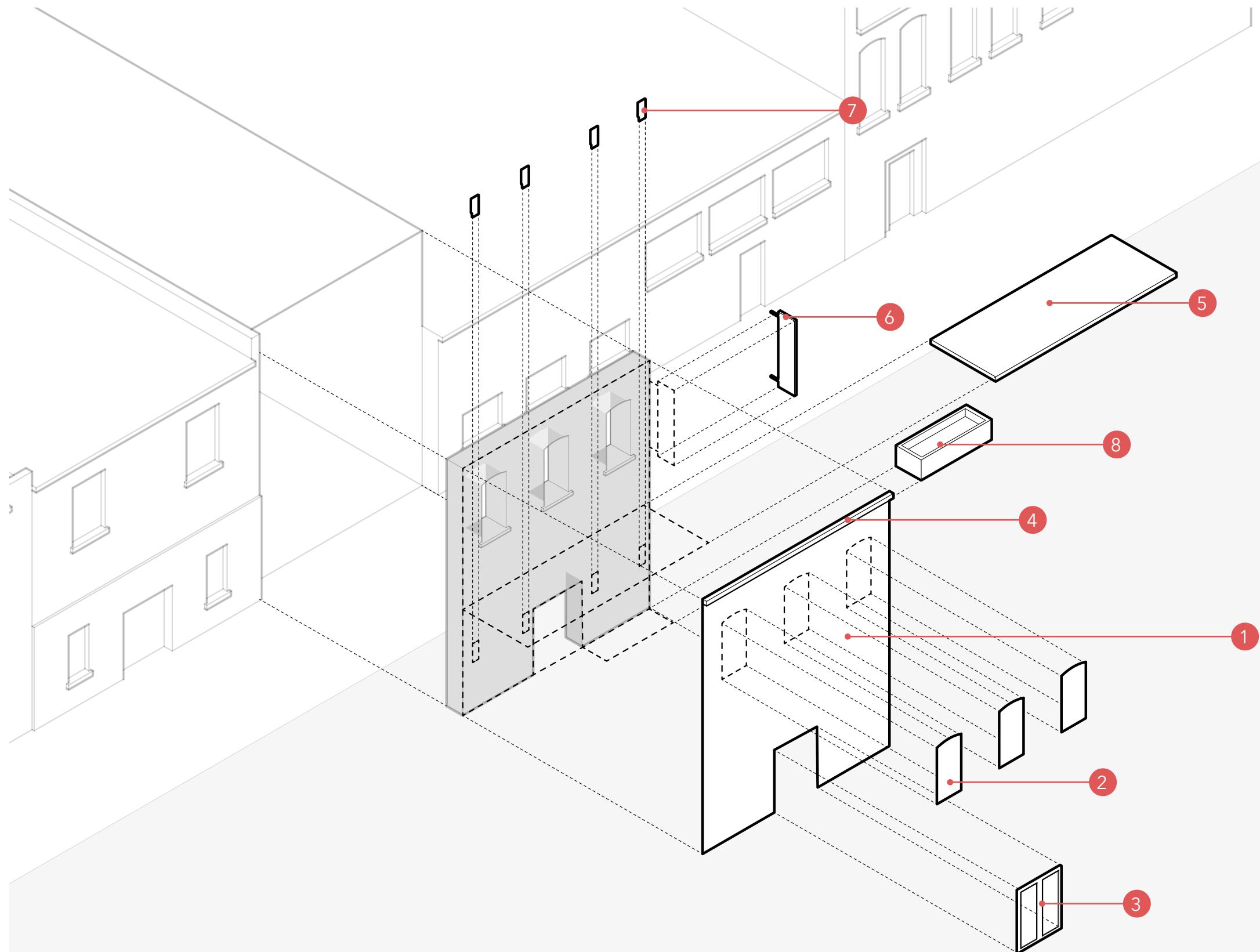

HOW TO USE THIS Improvement Kit

Each facade improvement kit is made up of the same component elements. Each kit maintains a similar formal language, but allows the individual building to present a unique face to the future plaza, creating a unique identity for the business or building, but promoting a vital community and some aesthetic continuity within the alley.

Within each kit, components serve a similar role, with similar shapes and proportions, although with different aesthetic values. These similarities create a commonality among the multiple alley facades, creating a legible whole, and crafting a community around Indian Creek Plaza. The various aesthetics of the (3) different kits are intentionally broad to allow each retailer to maintain a unique identity within the community.

Business owners are encouraged to either select from a singular kit or pick and choose from the three to further develop a facade design that works for their specific business goals, building limitations and budget within this basic framework.

KIT COMPONENTS

1. Facade
2. Fenestration
3. Entry
4. Cornice
5. Weather Protection
6. Signage
7. Lighting
8. Accessories

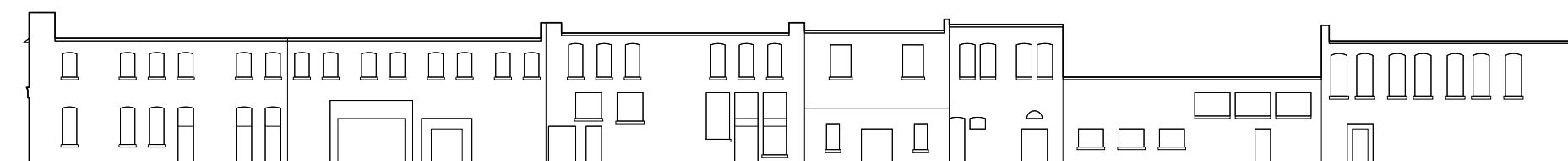

5 Existing Alley Facade

Kit #1 - Timeless Restoration

A historically sensitive renovation of the building facades and integrated components



Design imagery provided in this handbook is intended for use by building owners as design inspiration to revitalize building facades. While these ideas are encouraged, design is not limited to imagery provided, unless specifically stated. Actual facade design must be approved by the Caldwell Design Review Board.

Kit #2 - Respectfully Eclectic

A mix of restored pieces, newer systems and elements from other styles, with a similar vocabulary of materials and proportions.



It should be assumed by all building owners that any modifications to exterior walls, such as increase or decrease in glazing size, addition of canopy structure, removal of columns, etc., will be subject to a structural engineering review for structural integrity.

Kit #3 - Design-Oriented Contemporary

A contemporary update to the building facades, with a sensitive re-interpretation of materials and concepts.

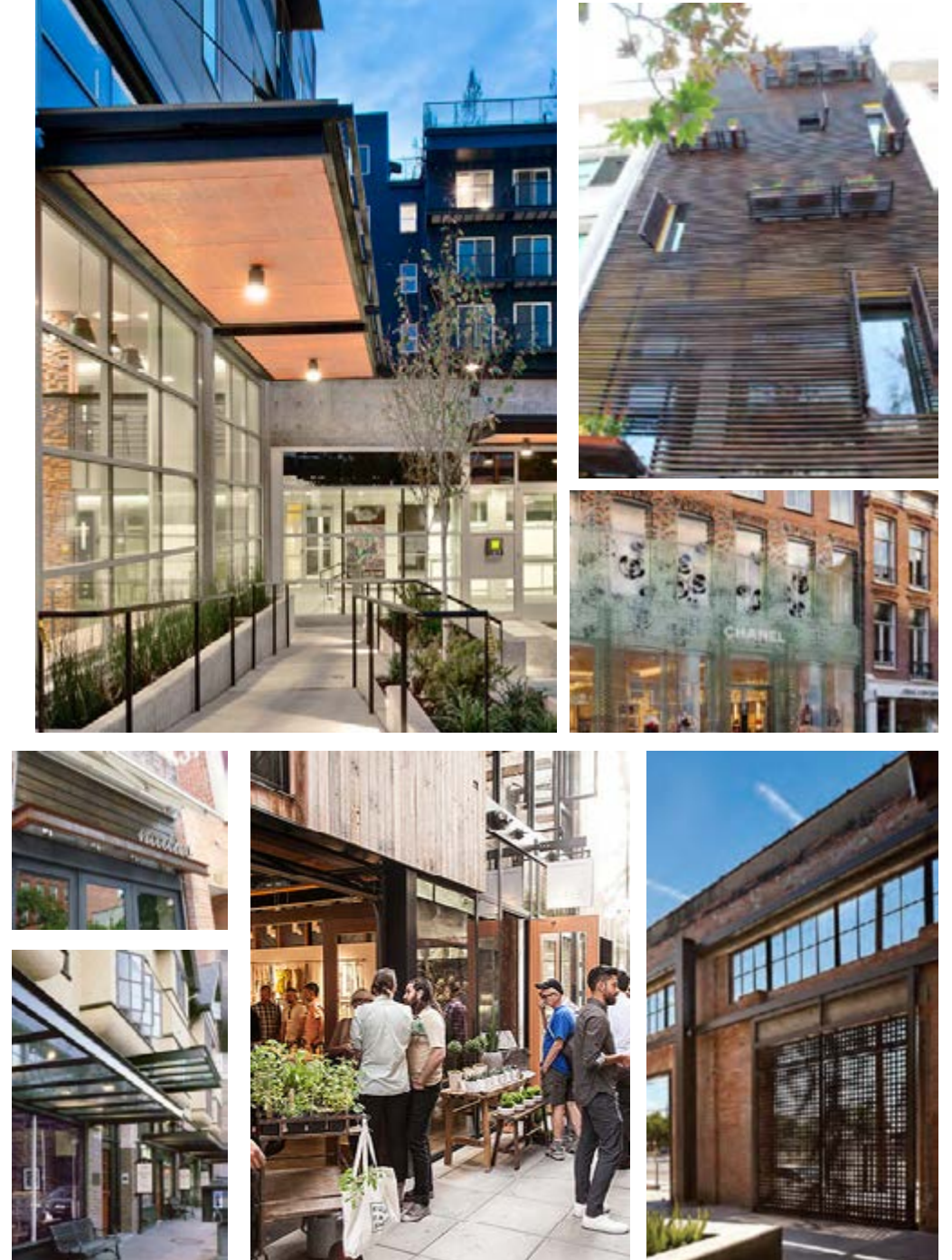

Plaza Facade Design Handbook

Indian Creek Plaza | Downtown Caldwell, ID 83605

1. Facade Materiality

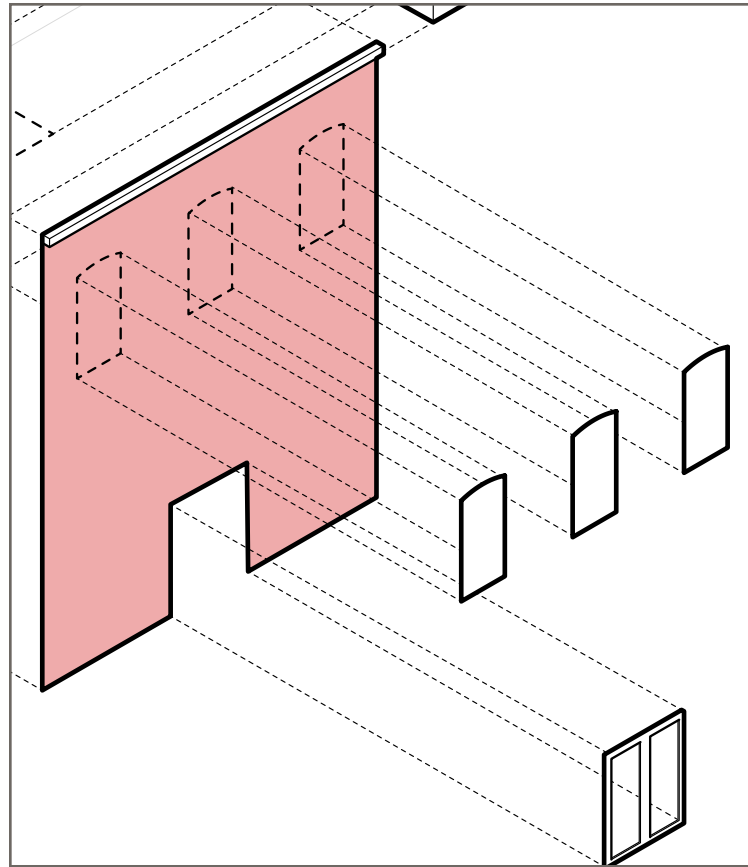

The facades, fenestration and entries of the alley and building fronts all act together, creating the overall face of the buildings on the plaza edge. Together, these three components set the overall tone of the building, setting it apart from it's neighbors.

The material palette of the facades is largely set by the stucco and brick of the existing buildings. Additional accent materials may be used as changes in plane occur.

All exterior facade materials are required to be durable, weather resistant materials typical to outdoor use.

All Kits

Cladding choices for major facade are:

- Restoring existing stucco facade
- Restoring and repairing existing brick masonry

Accent materials should be limited to approximately 20% of the overall facade. Cladding choices for facade accents are:

- Wood stained and sealed
- Painted Wood
- Painted Brick
- Tile
- Metal
- Terracotta cladding

All Kits

All metal elements are to be dark bronze or black anodized aluminum to create a cohesive aesthetic



Materials

Standard Materials:



Restore Existing Brick



Restore Existing Stucco

Accent Materials:



Painted Brick



Stained & Sealed Wood



Metal Panel



Terracotta Cladding



Tile

Color Palette

Standard Colors:

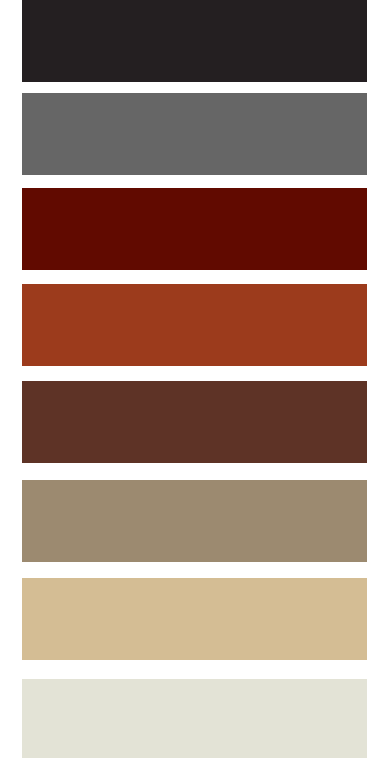

Accent Colors:



Plaza Facade Design Handbook

Indian Creek Plaza | Downtown Caldwell, ID 83605

Facade Materiality | 08 December, 2016

2. Fenestration

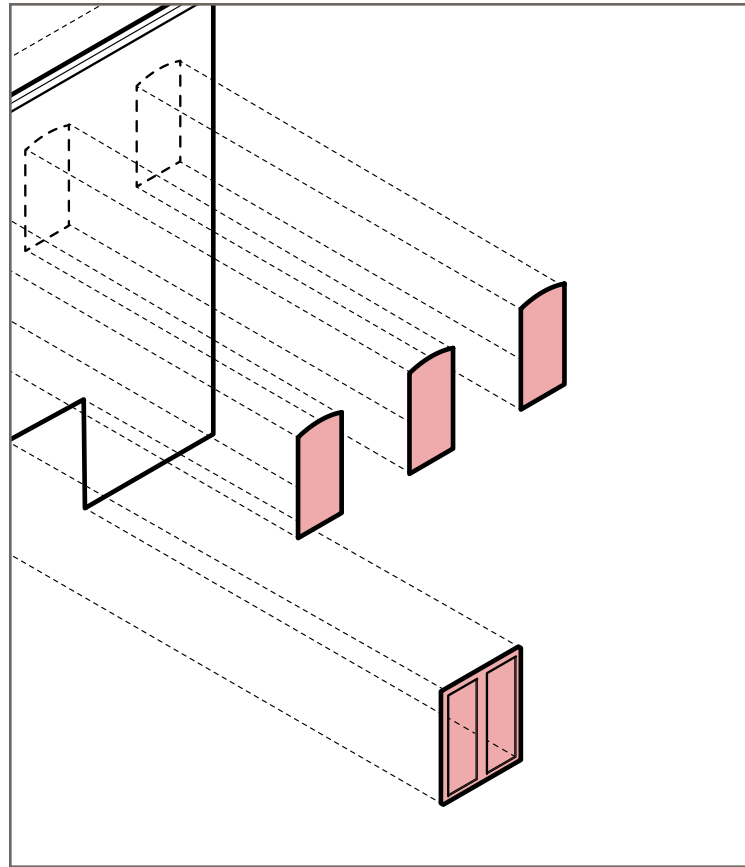

Kit #1 - Timeless Restoration

Accurate restoration of the facades to the construction period, as well as introduction of new elements that would also be found in storefronts at the time. The fenestration and facade work together, but rely on punched openings and true divided panes. The entries happen in plane with the facade, or happen as a portal projecting into the interior of the building.

Wood Storefront with true divided lites

- Duratherm
- Dynamic Architectural
- Approved Equal

Kit #2 - Respectfully Eclectic

A mix of restored pieces, newer systems and elements from other styles, with a similar vocabulary of materials and proportions.

Aluminum-Clad Wood Storefront

- Dynamic Architectural
- Approved Equal

Fiberglass-Clad Wood Storefront

- Pella
- Approved Equal

Kit #3 - Design-Oriented Contemporary

An artful use of materials and fabrication processes, with traditional forms, patterns and proportions, setting the facade in the contemporary period, but ties back to the original through a similar palette of materials and architecture. Non-planar brick walls, large openings & secondary walls allow for the multiple planes of inhabitation within the facade, for the fenestration and entry to create a textural space.

Aluminum Storefront

- Kawneer Aluminum Storefront
- Dynamic Architectural
- Approved equal

Custom Steel Storefront

- Hope's



2. Entry

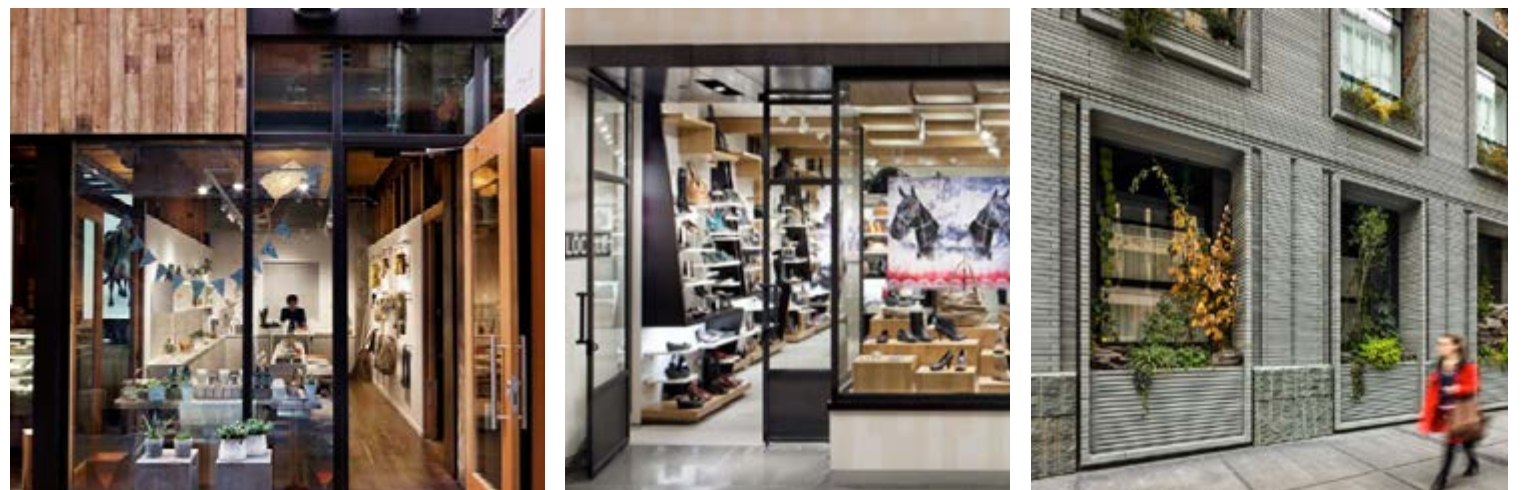
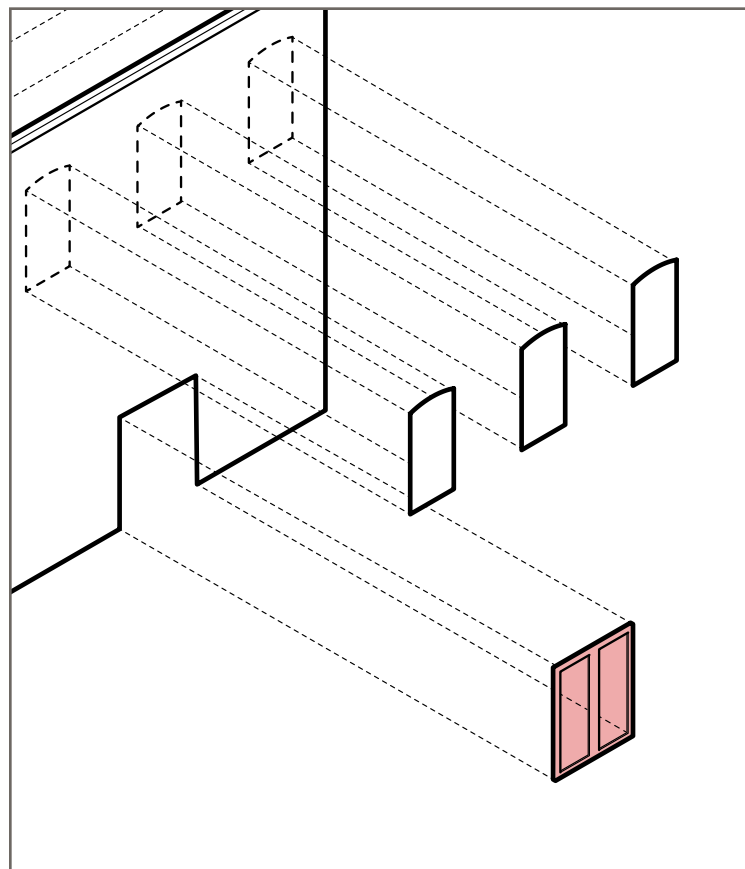

Plaza Facade Design Handbook

Indian Creek Plaza | Downtown Caldwell, ID 83605

08 December, 2016

GGLO DESIGN

4. Cornice

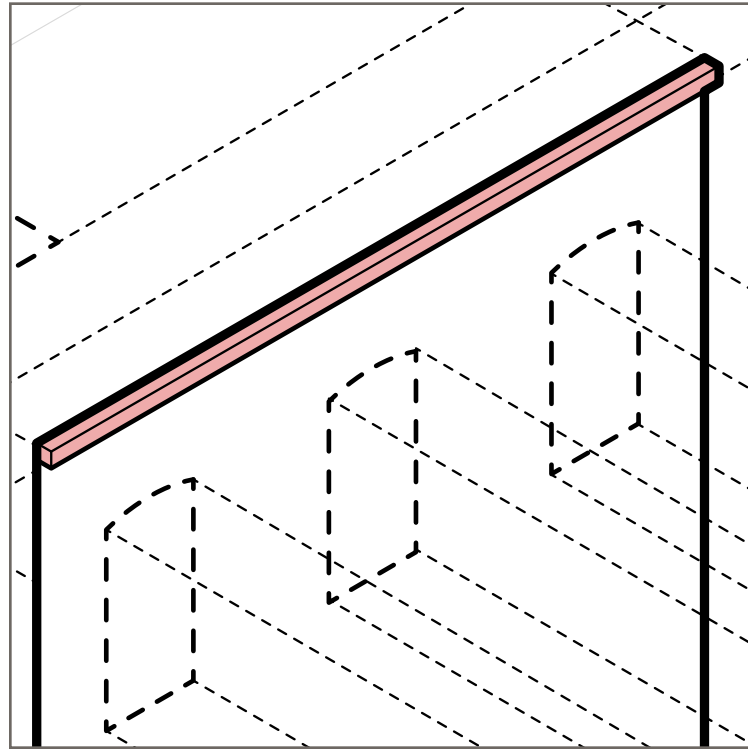

All Kits

The cornices place the building and alley facades within a certain historical context. In all facade renovations, if a decorative cornice is present, it should be maintained, but if absent, a new one should not be applied.

The parapets of buildings may be raised to be a single height across the length of an individually demised building as long as the structure is reinforced to accommodate the increased height.

A simple metal cap should protect the top of the wall cladding.



5. Weather Protection

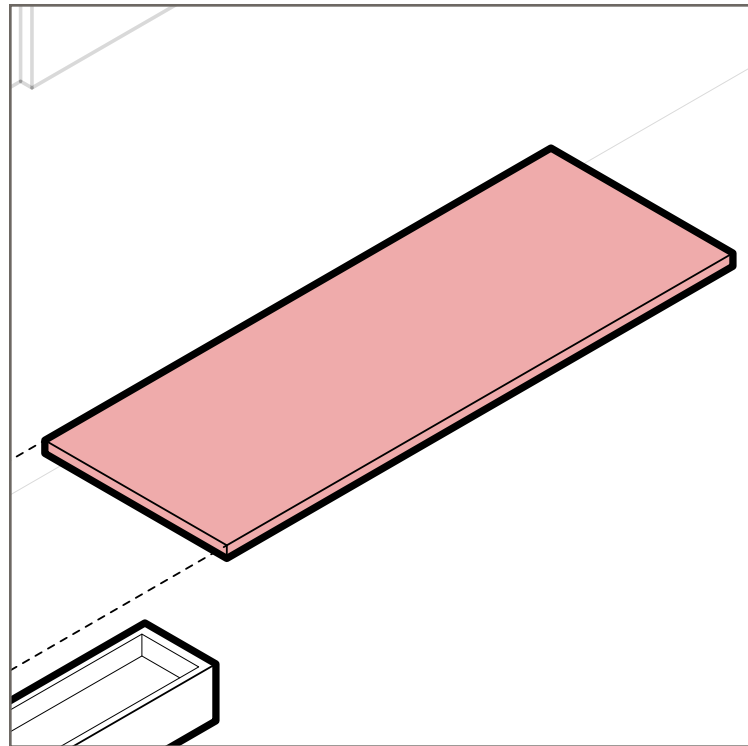

All Kits

Awnings and all other weather projection shall match the overall scheme of the building, and be sized to appropriately cover the space below, depending on the intended program.

Awnings over dining areas should be large enough to cover those dining, while weather protection over normal windows and circulation space shall be sized to cover the given window. No awning shall project more than 4' from the face of the building.

No awning shall be less than 10' or more than 15' from the ground plane.

Metal awnings shall be dark or black metal. Factory applied tmec paint is preferred. Fabric awning material to match canopy structure color (dark bronze or black) as preferred choice. Secondary color selection to be from color palette.

Integrated lighting is suggested



Kit #1 Retractable fabric awning



Kit #2 Steel frame with solid or retractable fabric



Kit #3 Steel frame canopy with material unique to retailer at underside

Plaza Facade Design Handbook

Indian Creek Plaza | Downtown Caldwell, ID 83605

08 December, 2016

GGLO DESIGN

6. Signage

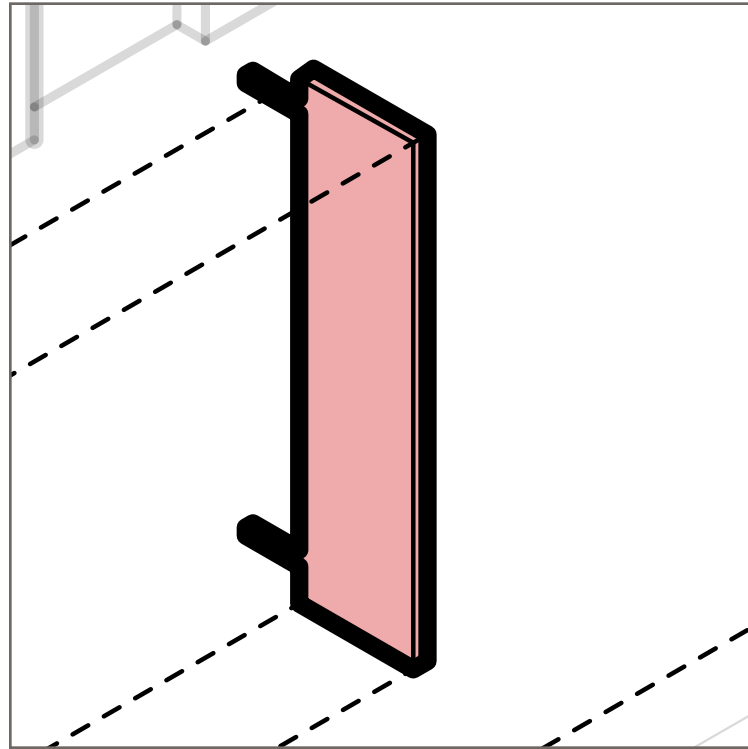

All Kits

Signage for the buildings shall fit the overall theme of the building, and also the character of the given shop or restaurant. Signage shall be designed and constructed by a professional and be permanently attached to the ground, building, or another structure.

All signs that project from the face of the building shall be no less than 8' from the ground plane and no more than 3' from the face of the building.

All signs that project from the face of the building shall have a surface area no more than 6 sq ft.

Materials

- Block Letters
- No Neon
- No Back-Lit Box Signs

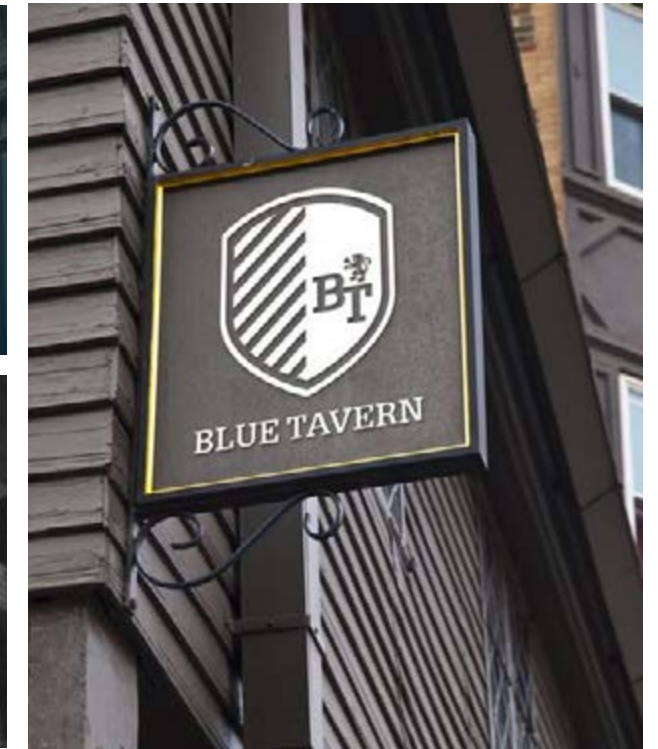

7. Lighting

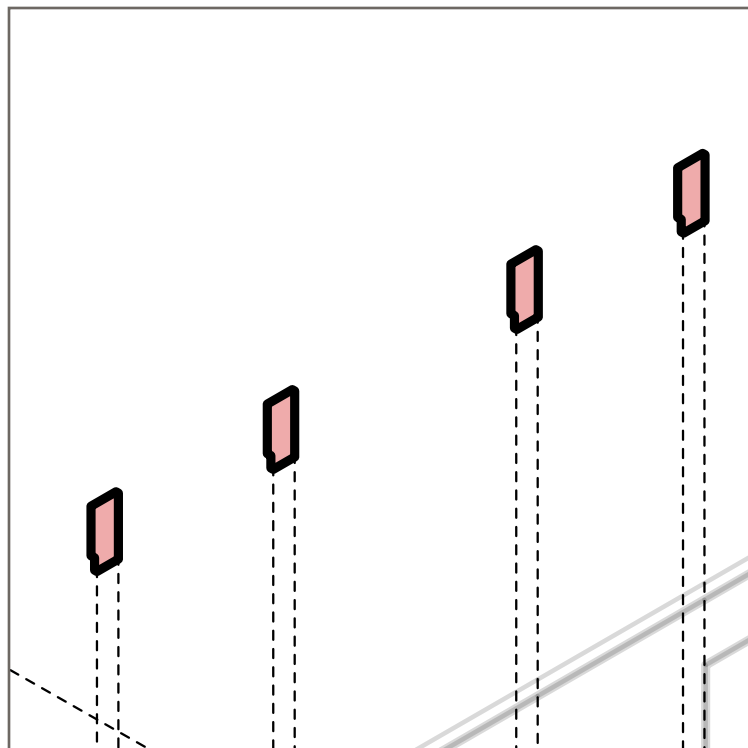

All Kits

Black metal gooseneck fixtures shall be introduced along the entirety of the Alley facades at a fixed height of 8' above finished grade. This will ensure a consistent level of illumination and a consistent aesthetic.

Approved Manufacturers are:

Lighting

- BOH Lighting
- Hilite
- Barnlight Electric
- Tivoli Lighting (Litesphere series)
- Celestial (Hydra STL Series)

Building owners and the city should reach a consensus on a single fixture type.

These fixtures will be required to be on a single timer or on continuously during the night.

All lights shall comply with dark sky standards. All lights shall be energy efficient, and warm white in color. Additional lighting choices could be integrated canopy lighting and/or catenary lighting.

Required - Gooseneck



Optional - Integrated Canopy Lights Optional - Catenary Lights



Plaza Facade Design Handbook

Indian Creek Plaza | Downtown Caldwell, ID 83605

08 December, 2016

8. Accessories

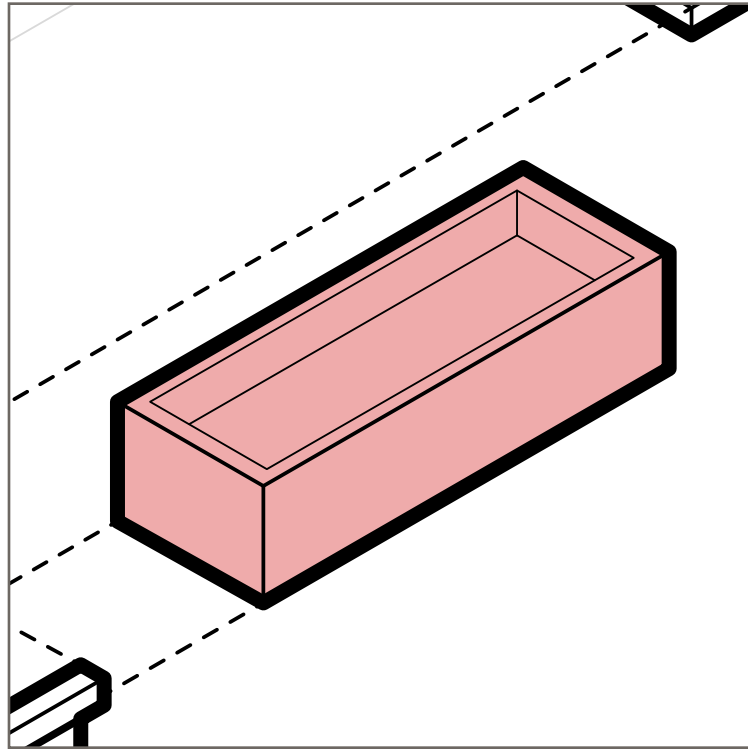

All accessories chosen shall match the character of the associated building facade. Materials and color should be similar or complimentary of those chosen for the facade.

High quality accessories should be chosen. Flat texture, satin or matte finish. Black metal or dark colors preferred. Wood accents are acceptable. *Facade accessories must be proportional to wall space, maintain a pedestrian friendly scale, and must not intrude into the user's space or pedestrian circulation.*

Approved manufacturers are:

Planters

- Tournesol Site Works
- International Art Properties
- Approved Equal

Bistro Seating & Benches

- Forms and Surfaces
- Victor Stanley
- Landscape Forms
- Approved Equal





Example Elevation
Proposed Use: Storage/Deliveries

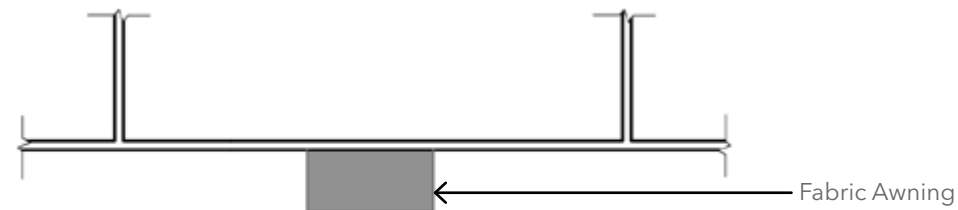

Example Reflected Ceiling Plans

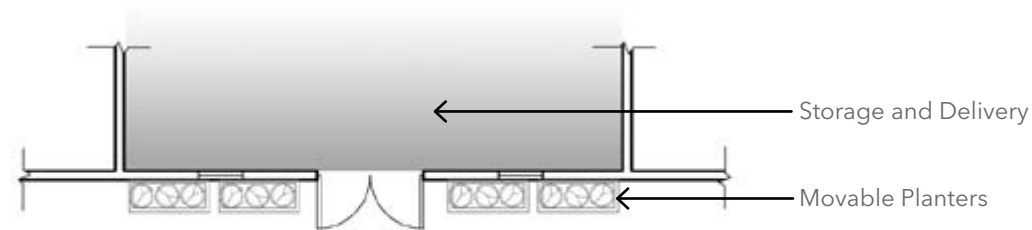

Example Plans

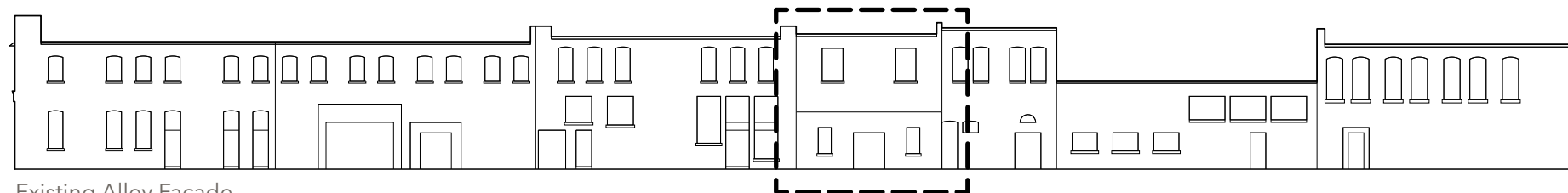

Basic Improvements

Restoring the facade and openings to original conditions while providing the basic requirements of weather protection, lighting, and signage. Street furnishings or accessories are recommended to provide a cohesive link with adjacent properties.



Kit #1 EXAMPLE: Timeless Restoration

A historically sensitive renovation of the building facades and integrated components



Example Elevation
Proposed Use: Retail Store

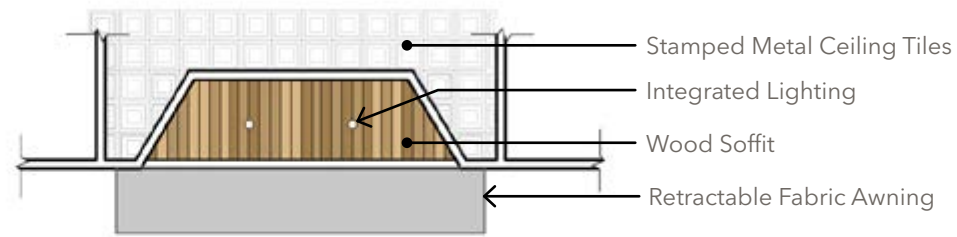

Example Reflected Ceiling Plan

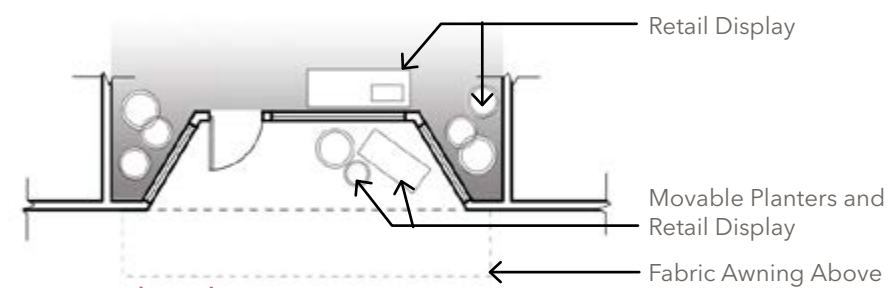

Example Plan



Kit #2 EXAMPLE: Respectfully Eclectic

A mix of restored pieces, newer systems and elements from other styles, with a similar vocabulary of materials and proportions.

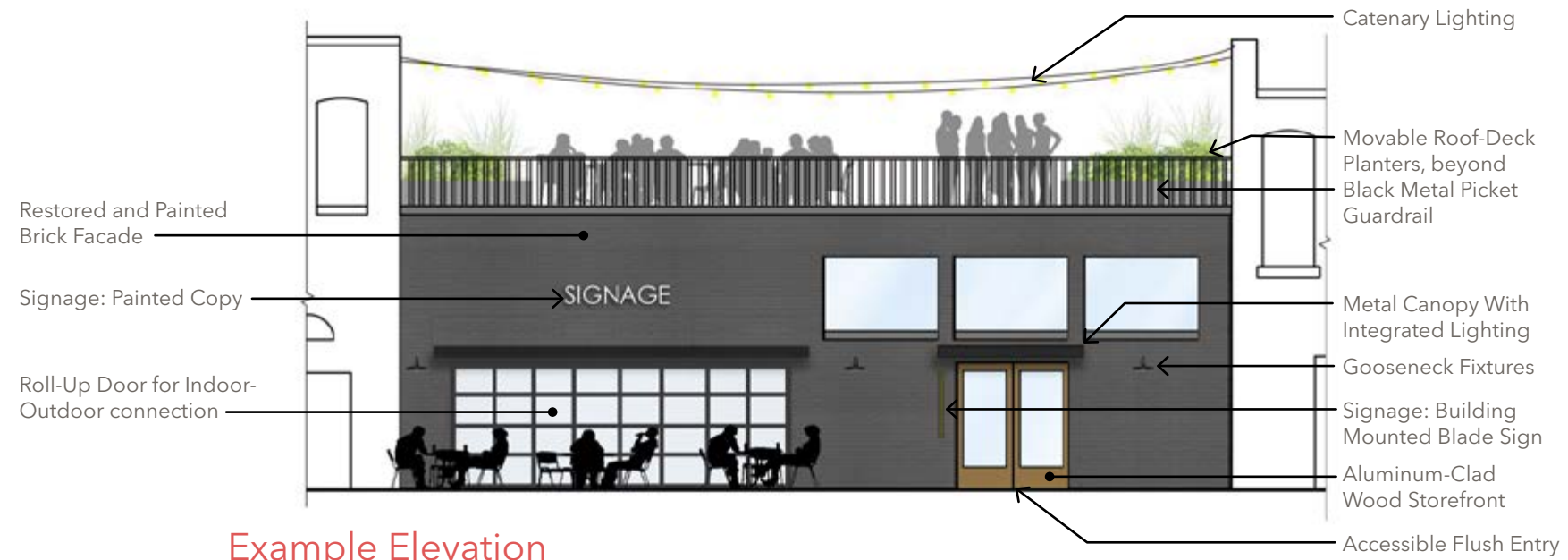

Example Elevation

Proposed Use: Restaurant with roof deck

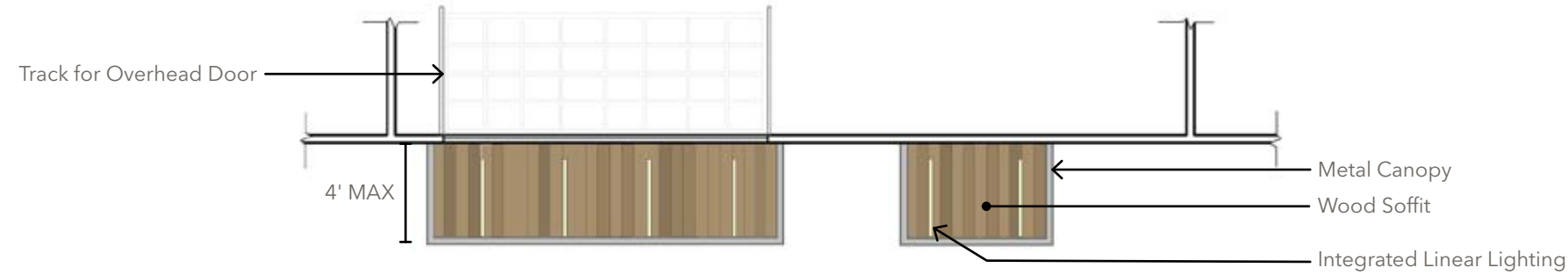

Example Reflected Ceiling Plan

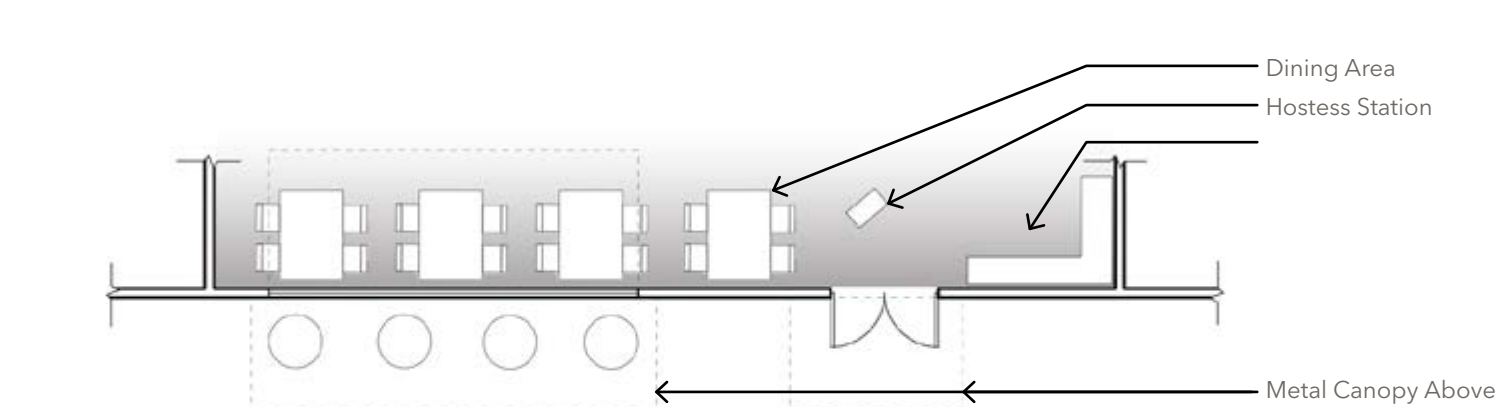

Example Plan

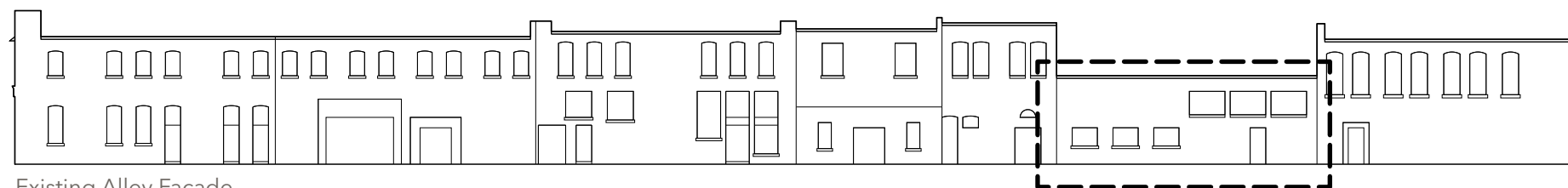

Kit #3 EXAMPLE- Design-Oriented Contemporary

A contemporary update to the building facades, with a sensitive re-interpretation of materials and concepts.



Example Elevations

Proposed Use: Coffee Shop

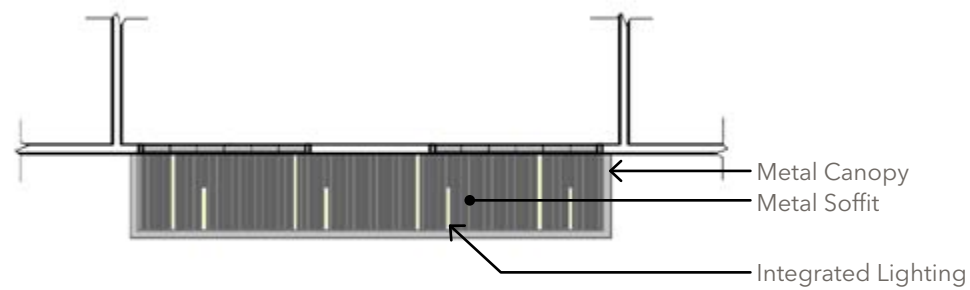

Example Reflected Ceiling Plans

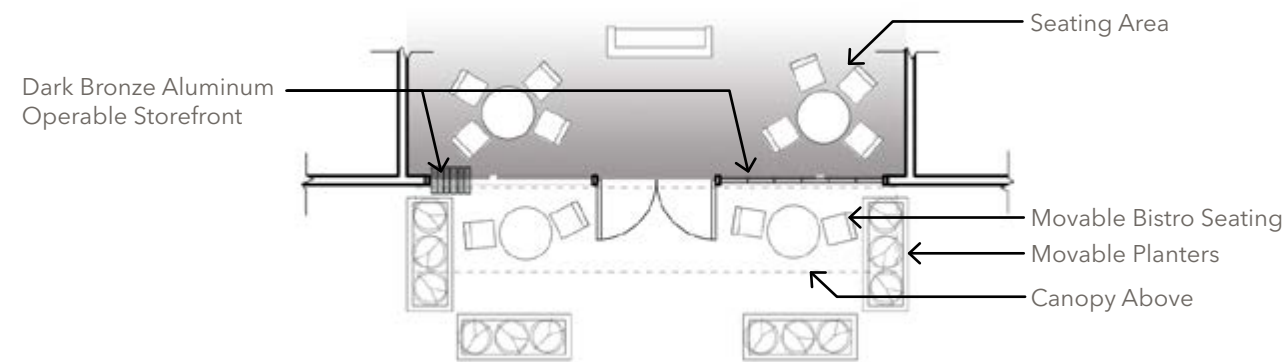

Example Plans

